

① 放火監視受信装置 < PCP-10 >

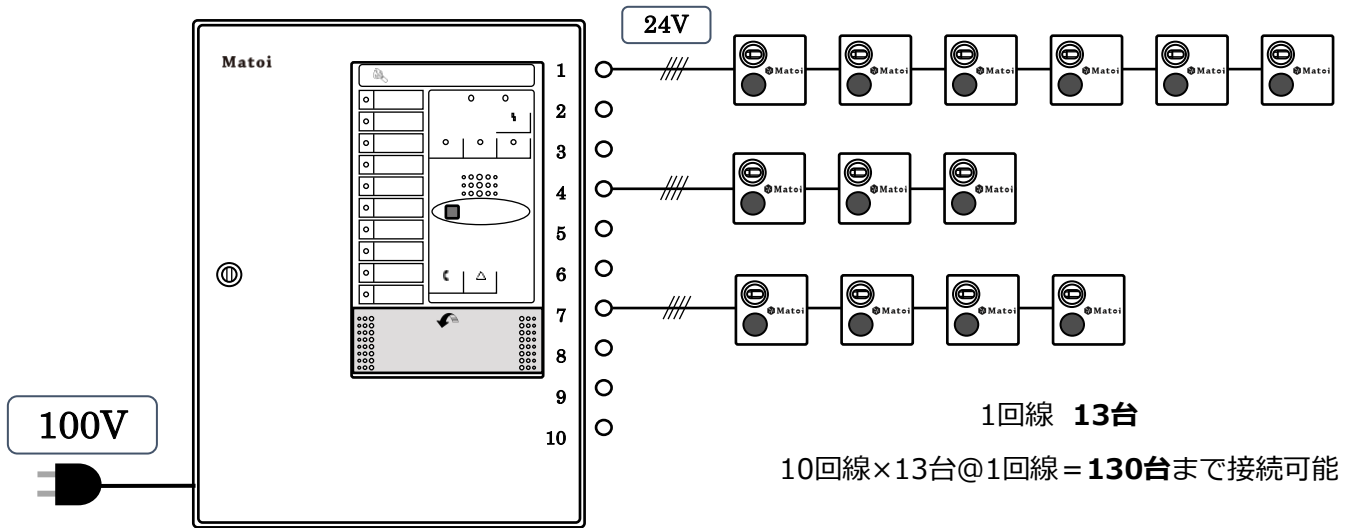

**Matoi 接続**

\* Matoiは12V~24Vにて作動します

\* 24V接続時

消費電流 参考値 48mA

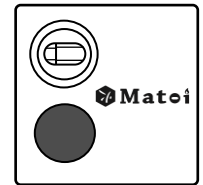
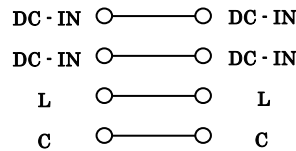
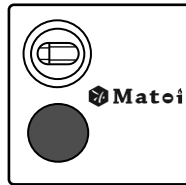
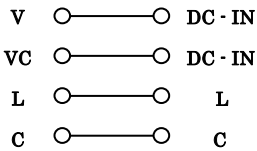
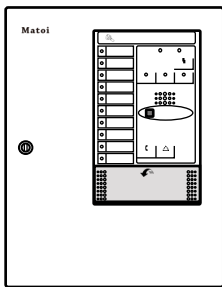

② 12V 1A電源アダプター < NH-E729 >

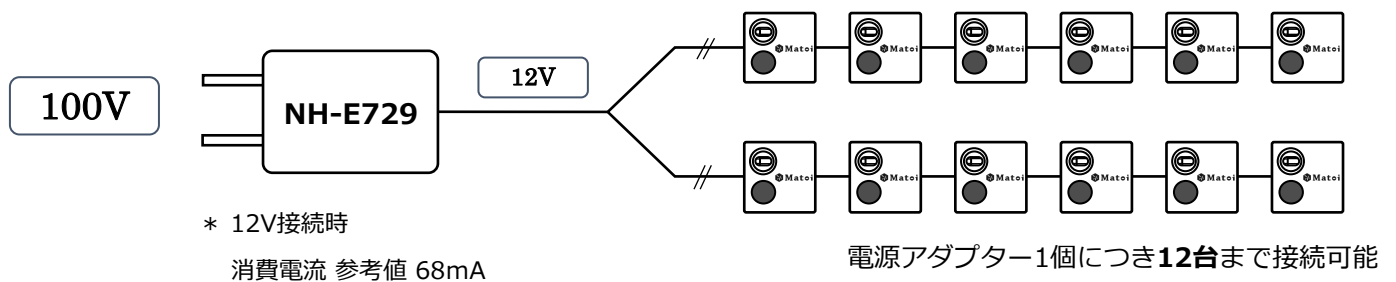

③ 12V 5A マルチ電源 < OS-E823 >

